

GPS/GNSS Receiver Module

1. Product Information

1.1 Product Name: YIC91612EBF



1.2 Product Description:

YIC91612EBF is a flash base, compact, high performance, and low power consumption GNSS engine board.

It uses the chipset which can track up to 56 channels at a time and perform fast TTFF in weak signal environments.

YIC91612EBF is suitable for the following applications:

- Automotive navigation
- Personal positioning
- Fleet management
- Mobile phone navigation
- Marine navigation

Product Features:

- High performance and low power consumption GNSS Chipset
- With 16Mbit flash
- Very high sensitivity
- Extremely fast TTFF (Time To First Fix) at low signal level
- Two serial ports
- Built-in LNA
- Compact size suitable for space-sensitive application
- One size component, easy to mount on another PCB board
- Support NMEA 0183 and ublox binary protocol

1.3 Product Specifications

GPS Performance

GPS Receiver	
Chipset	u-blox 7 (UBX-G7020)
Frequency	L1 frequency band
Code	C/A Code
Protocol	NMEA 0183 GALILEO L1 open service (with upgrade) Default:GGA,GSA,GSV,RMC Support:VTG,GLL,TXT ublox binary and NMEA Command
Available Baud Rate	9,600 bps
Channels	56
Sensitivity	Tracking:-161dBm Reacquisition:-160dBm ColdStart:-147dBm
Cold Start	29 seconds, average
Warm Start	28 seconds, average
Hot Start	1 second, average
Accuracy	HorizontalPosition:Autonomous<2.5maverage, SBAS < 2.0m average Velocity: 0.1 m/s Timepulse signal: RMS 30 ns
Maximum Altitude	50,000 meter
Maximum Velocity	515 m/s(1000 knots)
Dynamics	≅ 4G
Update Rate	4 Hz
A-GPS	AssistNow on-line and off-line
Interface	
I/O Pins	1 serial ports
Physical Characteristic	
Type	24 pin stamp holes
Dimensions	16.0mm * 12.2 mm * 2.4mm ±0.2mm

1.4 DC Electrical Characteristics

Parameter	Symbol	Conditions	Min.	Typ.	Max.	Units
Input Voltage	VCC		2.7	3.3	3.6	V
Input Backup Battery Voltage	V_BCKP		1.4		3.6	V
Supply Current	I _{ss}	VCC = 3.3V, w/o active antenna, Peak Acquisition Tracking Standby		24 16 ⁽²⁾ 365	150 ⁽¹⁾	mA mA mA uA
Backup Battery Current	I _{bat}	VCC = 0V		7		uA
High Level Input Voltage	V _{IH}		2.0		3.6	V
Low Level Input Voltage	V _{IL}		-0.3		0.8	V
High Level Input Current	I _{IH}	no pull-up or down	-1		1	uA
Low Level Input Current	I _{IL}	no pull-up or down	-1		1	uA
High Level Output Voltage	V _{OH}		2.4			V
Low Level Output Voltage	V _{OL}				0.4	V
High Level Output Current	I _{OH}			2		mA
Low Level Output Current	I _{OL}			2		mA

Note 1: This happens when downloading AGPS data to Module.

Note 2: Measured when position fix (1Hz) is available, input voltage is 3.3V and the function of self-generated ephemeris prediction is inactive.

Temperature characteristics

Parameter	Symbol	Min.	Typ.	Max.	Units
Operating Temperature	T _{opr}	-40	25	85	°C
Storage Temperature	T _{stg}	-40	25	85	°C

2. Block Diagram

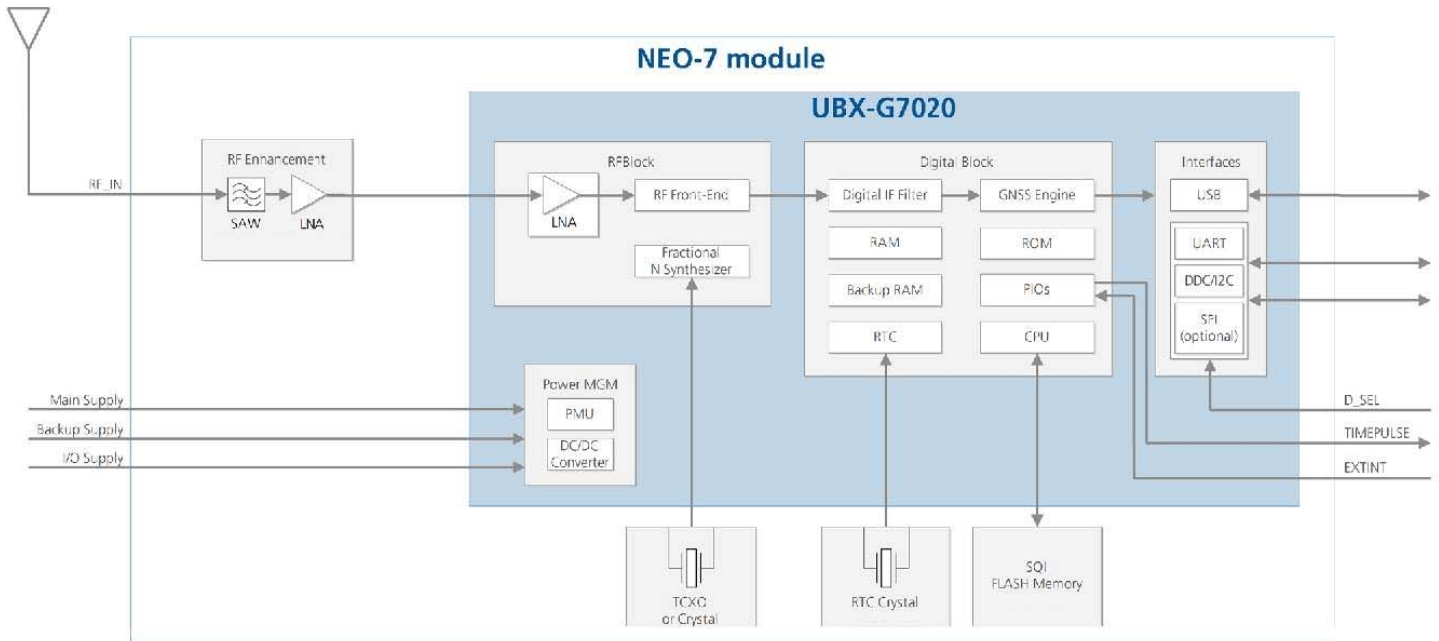

3. Module Pin Assignment

13 GND	GND	12
14 ANT_OK	RF IN	11
15 ANT_OFF	GND	10
16 RESET_N	VCC RF	9
17 EXTINT1	NC	8
18 SDA	VDD_USB	7
19 SCL	USB DP	6
20 TXD	USB_DM	5
21 RXD	EXTINT0	4
22 V_BAT	TIMEPULSE	3
23 VCC	NC	2
24 GND	SAFEBOOT	1

Pin NO.	Pin Name	I/O	Remark
1.	SAFEBOOT	I	Leave Open if not used
2.	NC	I	Leave Open if not used
3.	TIMEPULSE	I/O	Time pulse (1PPS)
4.	EXTINT0	I	External Interrupt Pin
5.	USB_DM	I/O	USB Data
6.	USB_DP	I/O	USB Data
7.	VDD_USB	I	USB Supply
8.	NC	I	Leave Open if not used
9.	RF_VCC	O	Output Voltage RF section
10.	GND	G	Ground.
11.	RF_IN	I	GNSS Signal Input
12.	GND	G	Ground.
13.	GND	G	Ground.
14.	ANT_OK	I/O	Antenna status of antenna supervisor
15.	ANT_OFF	I/O	Antenna power control of antenna supervisor
16.	RESET_N	I/O	Leave Open if not used
17.	EXTINT1	I	External Interrupt Pin
18.	DDC_SDA	I/O	DDC Data
19.	DDC_SCL	I/O	DDC Clock
20.	TXD	O	UART Serial Data Output Pull up (75K Ω) if not used
21.	RXD	I	UART Serial Data Input Pull up (75K Ω) if not used
22.	V_BAT	P	Backup battery supply voltage
23.	VCC	P	DC supply voltage
24.	GND	G	Ground.

4. Dimensions

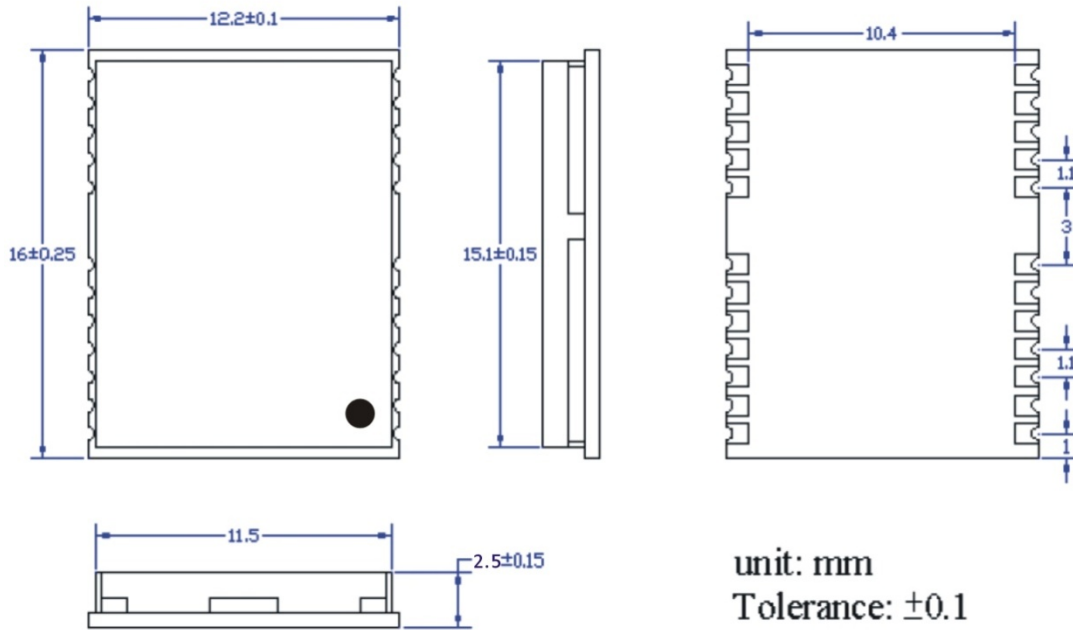

5. Recommended Footprint

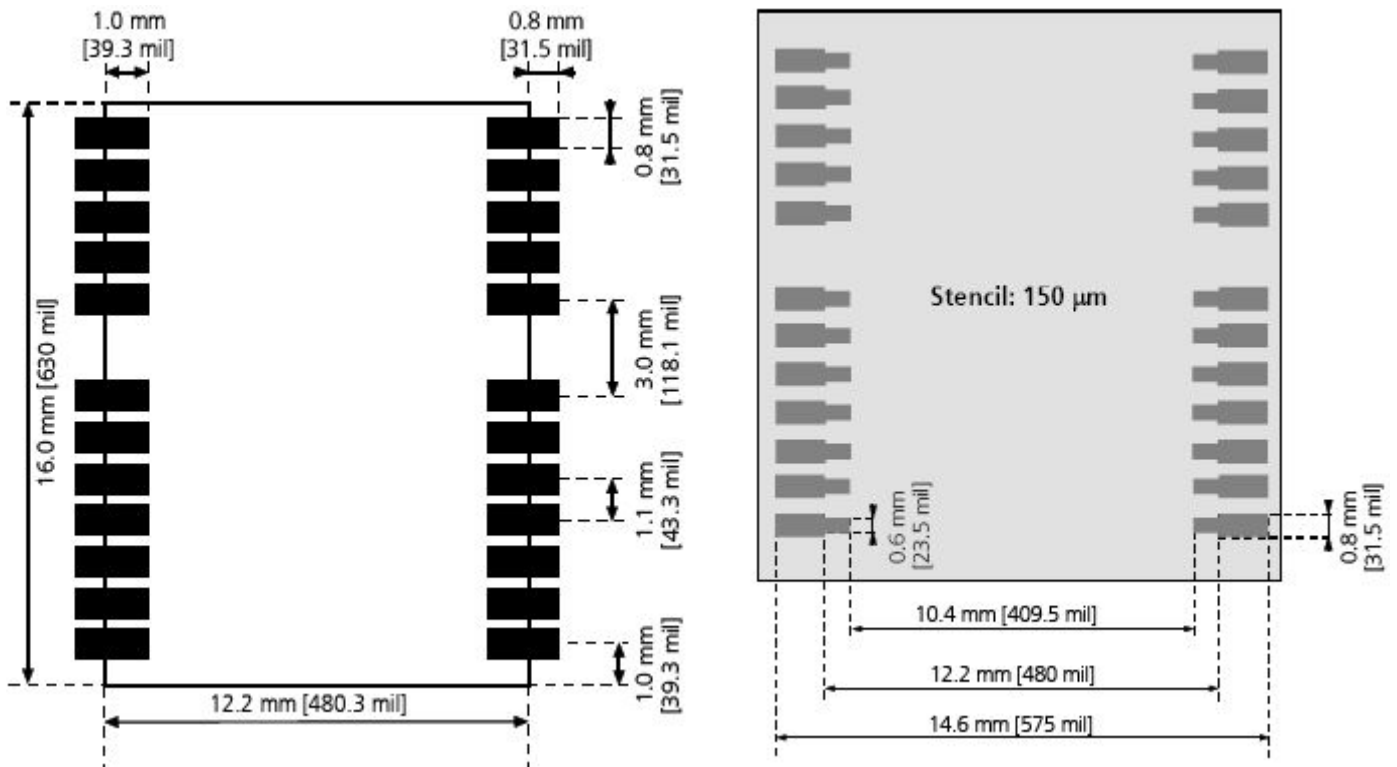

6. Application Circuit

6.1 With Active Antenna

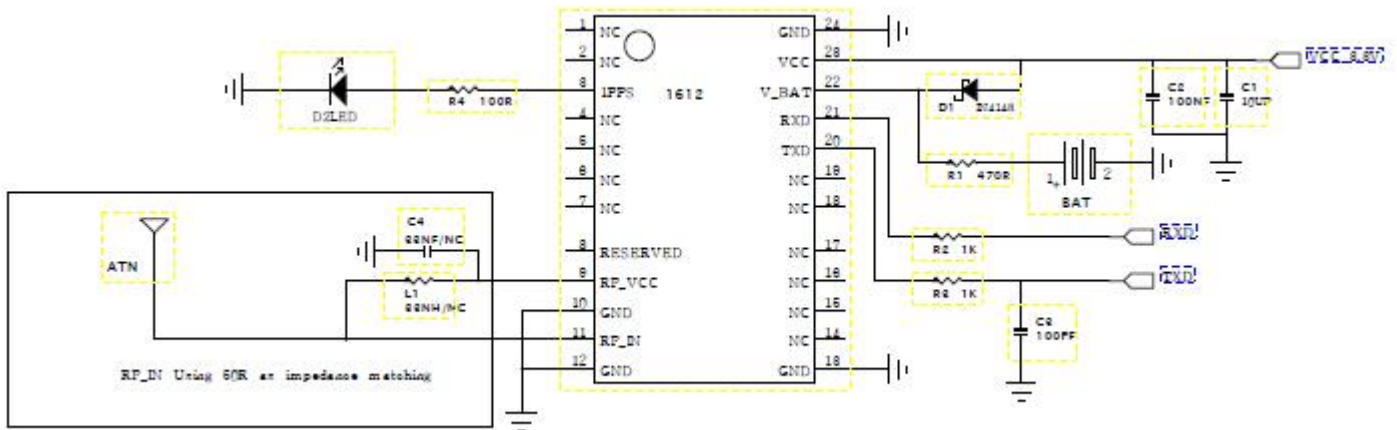

6.2 With Passive Antenna ,LNA & SAW Filter

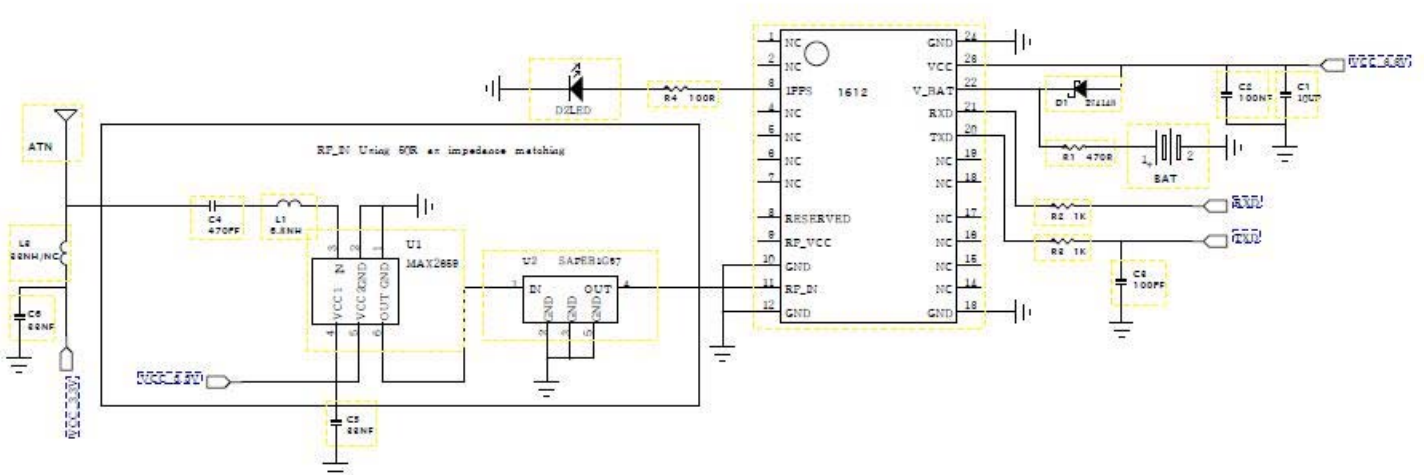

7. Reflow Profile

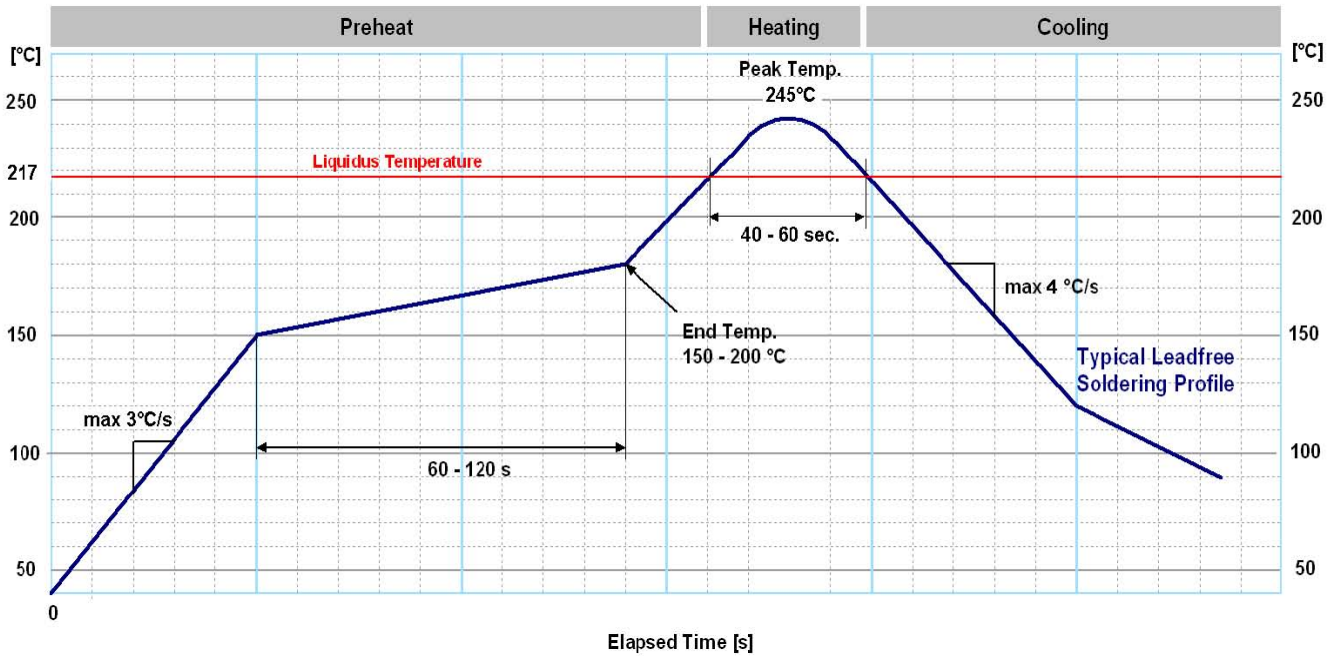

8. Tape & Reel (unit : mm)

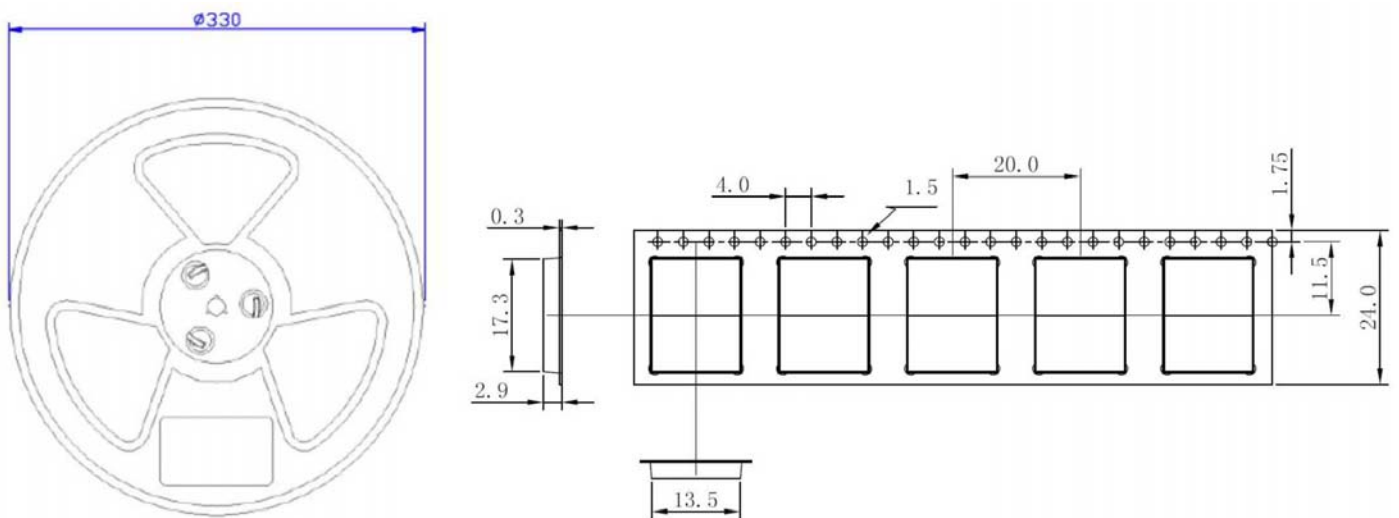

9. Software Interface

NMEA output message

Table 9.1 NMEA output message

NMEA	Description
GGA	Global positioning system fixed data
GLL	Geographic position - latitude/longitude
GSA	GNSS DOP and active satellites
GSV	GNSS satellites in view
RMC	Recommended minimum specific GNSS data
VTG	Course over ground and ground speed

GGA--- Global Positioning System Fixed Data

Table 9.2 contains the values for the following example:

\$GPGGA,060406.000,2503.7148,N,12138.7451,E,2,17,0.71,116.7,M,15.3,M,0000,0000*6D

Table 9.2 GGA Data Format

Name	Example	Units	Description
Message ID	\$GPGGA		GGA protocol header
UTC Time	060406.000		hhmmss.sss
Latitude	2503.7148		ddmm.mmmm
N/S indicator	N		N=north or S=south
Longitude	12138.7451		dddmm.mmmm
E/W Indicator	E		E=east or W=west
Position Fix Indicator	2		See Table 9.3
Satellites Used	17		Range 0 to 33
HDOP	0.71		Horizontal Dilution of Precision
MSL Altitude	116.7	mters	
Units	M	mters	
Geoid Separation	15.3	mters	
Units	M	mters	
Age of Diff. Corr.	0000	second	Null fields when DGPS is not used
Diff. Ref. Station ID	0000		
Checksum	*6D		
<CR> <LF>			End of message termination

Table 9.3 Position Fix Indicators

Value	Description
0	Fix not available or invalid
1	GPS SPS Mode, fix valid
2	Differential GPS, SPS Mode, fix valid
3-5	Not supported
6	Dead Reckoning Mode, fix valid

GLL--- Geographic Position – Latitude/Longitude

Table 9.4 contains the values for the following example:

\$GNGLL,2503.7148,N,12138.7451,E,060406.000,A,D*46

Table 9.4 GLL Data Format

Name	Example	Units	Description
Message ID	\$GNGLL		GLL protocol header (GPGLL or GNGLL; GP indicates the device receives GPS satellites signal only and GN indicates the position is calculated with BEIDOU satellite signal)
Latitude	2503.7148		ddmm.mmmm
N/S indicator	N		N=north or S=south
Longitude	12138.7451		dddmm.mmmm
E/W indicator	E		E=east or W=west
UTC Time	060406.000		hhmmss.sss
Status	A		A=data valid or V=data not valid
Mode	D		A=autonomous, D=DGPS, E=DR, N=Data not valid, R=Coarse Position, S=Simulator
Checksum	*46		
<CR> <LF>			End of message termination

GSA---GNSS DOP and Active Satellites

Table 9.5 contains the values for the following example:

\$GNGSA,A,3,22,21,18,12,24,25,14,15,193,,,,,1.18,0.71,0.95*2C

\$GNGSA,A,3,205,207,210,202,201,203,209,208,,,,,1.18,0.71,0.95*1C

Table 9.5 GSA Data Format

Name	Example	Units	Description
Message ID	\$GNGSA		GSA protocol header (GNGSA or GPGSA; GP indicates the device receives GPS satellites signal only and GN indicates the position is calculated with BEIDOU satellite signal). First row of GSA message contains GPS & QZSS satellites and second row of GSA message contains BEIDOU satellites.
Mode 1	A		See Table 9.6
Mode 2	3		See Table 9.7
ID of satellite used	22		Sv on Channel 1
ID of satellite used	21		Sv on Channel 2
....		
ID of satellite used			Sv on Channel 12
PDOP	1.18		Position Dilution of Precision
HDOP	0.71		Horizontal Dilution of Precision
VDOP	0.95		Vertical Dilution of Precision
Checksum	*2C		
<CR> <LF>			End of message termination

Table 9.6 Mode 1

Value	Description
M	Manual- forced to operate in 2D or 3D mode
A	Automatic-allowed to automatically switch 2D/3D

Table 9.7 Mode 2

Value	Description
1	Fix not available
2	2D
3	3D

GSV---GNSS Satellites in View

Table 9.8 contains the values for the following example:

\$GPGSV,6,1,21,18,78,169,36,209,72,273,36,22,63,309,38,207,63,328,38*7B

\$GPGSV,6,2,21,203,58,205,39,25,56,138,39,201,55,141,34,206,50,168,*45

\$GPGSV,6,3,21,210,49,282,34,12,48,076,39,204,39,118,,14,38,322,37*77

\$GPGSV,6,4,21,193,37,180,34,202,36,246,29,24,23,041,34,31,21,244,*71

\$GPGSV,6,5,21,21,17,198,33,205,16,258,28,15,12,092,33,208,09,169,30*7B

\$GPGSV,6,6,21,51,,,*7E

Table 9.8 GSV Data Format

Name	Example	Units	Description
Message ID	\$GPGSV		GSV protocol header
Total number of messages1	6		Range 1 to 6
Message number1	1		Range 1 to 6
Satellites in view	21		
Satellite ID	18		Channel 1 (Range 01 to 237), GPS Satellites ID : 01~32, SBAS Satellites ID : 33~64, QZSS Satellites ID:193~196, &BEIDOU Satellites ID : 201~214
Elevation	78	degrees	Channel 1 (Range 00 to 90)
Azimuth	169	degrees	Channel 1 (Range 000 to 359)
SNR (C/No)	36	dB-Hz	Channel 1 (Range 00 to 99, null when not tracking)
....
Satellite ID	207		Channel 4 (Range 01 to 237) , GPS Satellites ID : 01~32, SBAS Satellites ID : 33~64, QZSS Satellites ID:193~196, &BEIDOU Satellites ID : 201~214
Elevation	63	degrees	Channel 4 (Range 00 to 90)
Azimuth	328	degrees	Channel 4 (Range 000 to 359)
SNR (C/No)	38	dB-Hz	Channel 4 (Range 00 to 99, null when not tracking)
Checksum	*7B		
<CR> <LF>			End of message termination

Depending on the number of satellites tracked multiple messages of GSV data may be required.

RMC---Recommended Minimum Specific GNSS Data

Table 9.9 contains the values for the following example:

\$GNRMC,060406.000,A,2503.7148,N,12138.7451,E,0.01,0.00,180313,,D*78

Table 9.9 RMC Data Format

Name	Example	Units	Description
Message ID	\$GNRMC		RMC protocol header (GNRMC or GPRMC; GP indicates the device receives GPS satellites signal only and GN indicates the position is calculated with BEIDOU satellite signal)
UTC Time	060406.000		hhmmss.sss
Status	A		A=data valid or V=data not valid
Latitude	2503.7148		ddmm.mmmm
N/S Indicator	N		N=north or S=south
Longitude	12138.7451		dddmm.mmmm
E/W Indicator	E		E=east or W=west
Speed over ground	0.01	knots	True
Course over ground	0.00	degrees	
Date	180313		ddmmyy
Magnetic variation		degrees	
Variation sense			E=east or W=west (Not shown)
Mode	D		A=autonomous, D=DGPS, E=DR, N=Data not valid, R=Coarse Position, S=Simulator
Checksum	*78		
<CR> <LF>			End of message termination

VTG---Course Over Ground and Ground Speed

Table 9.10 contains the values for the following example:

\$GPVTG,0.00,T,,M,0.01,N,0.02,K,D*3B

Table 9.10 VTG Data Format

Name	Example	Units	Description
Message ID	\$GPVTG		VTG protocol header
Course over ground	0.00	degrees	Measured heading
Reference	T		True
Course over ground		degrees	Measured heading
Reference	M		Magnetic
Speed over ground	0.01	knots	Measured speed
Units	N		Knots
Speed over ground	0.02	km/hr	Measured speed
Units	K		Kilometer per hour
Mode	D		A=autonomous, D=DGPS, E=DR, N=Data not valid, R=Coarse Position, S=Simulator
Checksum	*3B		
<CR> <LF>			End of message termination