

GPS & BDS Receiver Module

1. Product Information

1.1 Product Name: YIC91612EBFGB-U8



1.2 Product Description:

YIC91612EBFGB-U8 is a flash base, compact, high performance and low power consumption, standalone multiple GNSS module. The module can simultaneously acquire and track multiple satellite constellations that include GPS, GLONASS, BEIDOU, GALILEO, QZSS and SBAS. It features low power and small form factor.

YIC91612EBFGB-U8 is suitable for the following applications:

- Automotive navigation
- Personal positioning
- Fleet management
- Mobile phone navigation
- Marine navigation

Product Features:

- High performance and low power consumption GNSS Chipset
- Very high sensitivity
- With 16Mbit flash
- Extremely fast TTFF (Time To First Fix) at low signal level
- Built-in LNA
- Compact size suitable for space-sensitive application
- One size component, easy to mount on another PCB board
- Support NMEA 0183 and binary protocol

1.3 Product Specifications

GNSS Performance

GNSS Performance	
Chipset	u-blox M8 (UBX-M8030)
Receiver type	GPS/QZSS L1 C/A , BeiDou B1 Galileo E1B/C (additional Flash required) SBAS L1 C/A:WAAS, EGNOS, MSAS
Code	C/A Code
Protocol	NMEA 0183 Default:GGA,GSA,GSV,RMC Support:VTG,GLL,TXT binary and NMEA Command
Available Baud Rate	9,600 bps (Default)
Channels	72
Sensitivity	Tracking:-167dBm Reacquisition:-160dBm ColdStart:-148dBm HotStart:-156dBm
Cold Start	26 seconds, average
Aided Start	2 seconds, average
Hot Start	1 second, average
Accuracy	HorizontalPosition:Autonomous<2.5m average, SBAS < 2.0m average Velocity: 0.1 m/s Timepulse signal: RMS 30 ns
Maximum Altitude	50,000 meter
Maximum Velocity	500 m/s(1000 knots)
Dynamics	≅ 4G
Update Rate	Single GNSS up to 18Hz Concurrent GNSS up to 10Hz
A-GPS	AssistNow on-line and off-line
Interface	
I/O Pins	1 serial ports
Physical Characteristic	
Type	24 pin stamp holes
Dimensions	16.0mm * 12.2 mm * 2.4mm ±0.2mm

1.4 DC Electrical Characteristics

Parameter	Symbol	Conditions	Min.	Typ.	Max.	Units
Input Voltage	VCC		3.0	3.3	3.6	V
Input Backup Battery Voltage	V_BCKP		2.0		3.6	V
Supply Current	I _{ss}	VCC = 3.3V, w/o active antenna, Peak Acquisition Tracking Standby		24 16 ⁽²⁾ 365	150 ⁽¹⁾	mA mA mA uA
Backup Battery Current	I _{bat}	VCC = 0V		7		uA
High Level Input Voltage	V _{IH}		2.0		3.6	V
Low Level Input Voltage	V _{IL}		-0.3		0.8	V
High Level Input Current	I _{IH}	no pull-up or down	-1		1	uA
Low Level Input Current	I _{IL}	no pull-up or down	-1		1	uA
High Level Output Voltage	V _{OH}		2.4			V
Low Level Output Voltage	V _{OL}				0.4	V
High Level Output Current	I _{OH}			2		mA
Low Level Output Current	I _{OL}			2		mA

Note 1: This happens when downloading AGPS data to Module.

Note 2: Measured when position fix (1Hz) is available, input voltage is 3.3V and the function of self-generated ephemeris prediction is inactive.

Temperature characteristics

Parameter	Symbol	Min.	Typ.	Max.	Units
Operating Temperature	T _{opr}	-40	25	85	°C
Storage Temperature	T _{stg}	-40	25	85	°C

2. Block Diagram

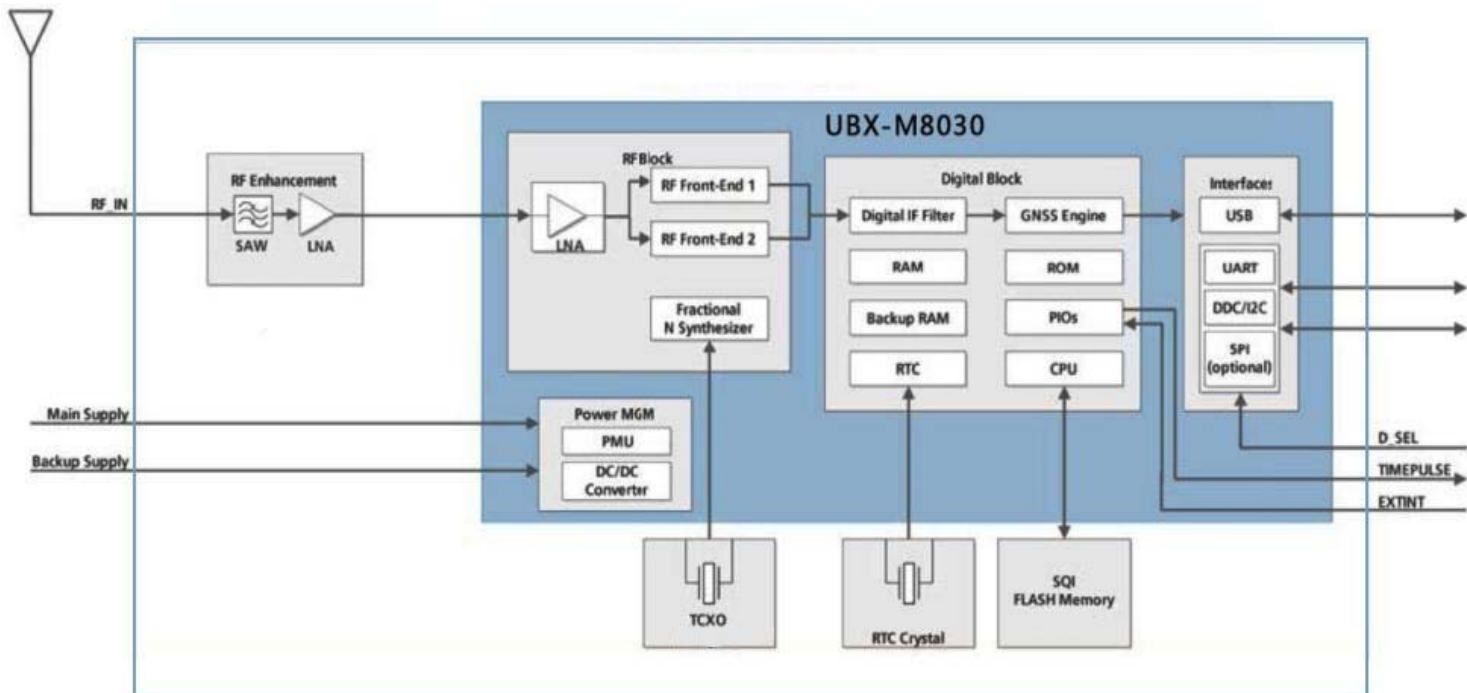

3. Module Pin Assignment

13	GND	GND	12
14	NC	RF_IN	11
15	NC	GND	10
16	NC	RF_VCC	9
17	NC	NC	8
18	DDCSDA	VDD_USB	7
19	DDCSCL	USB_DP	6
20	TXD	USB_DM	5
21	RXD	NC	4
22	V_BAT	TIMEPULSE	3
23	VCC	NC	2
24	GND	NC	1

Pin NO.	Pin Name	I/O	Remark
1.	NC	N	Not Connect
2.	NC	N	Not Connect
3.	TIMEPULSE	I/O	One pulse per second.
4.	NC	N	Not Connect
5.	USB_DM	I/O	USB Data
6.	USB_DP	I/O	USB Data
7.	VDD_USB	I	USB Supply
8.	NC	N	Not Connect
9.	RF_VCC	O	Output Voltage RF section
10.	GND	G	Ground.
11.	RF_IN	I	GNSS Signal Input
12.	GND	G	Ground.
13.	GND	G	Ground.
14.	NC	N	Not Connect
15.	NC	N	Not Connect
16.	NC	N	Not Connect
17.	NC	N	Not Connect
18.	DDC SDA	I/O	DDC Data
19.	DDC SCL	I/O	DDC Clock
20.	TXD	O	UART Serial Data Output Pull up (75K Ω) if not used
21.	RXD	I	UART Serial Data Input Pull up (75K Ω) if not used
22.	V_BAT	P	Backup battery supply voltage
23.	VCC	P	DC supply voltage
24.	GND	G	Ground.

4. Dimensions

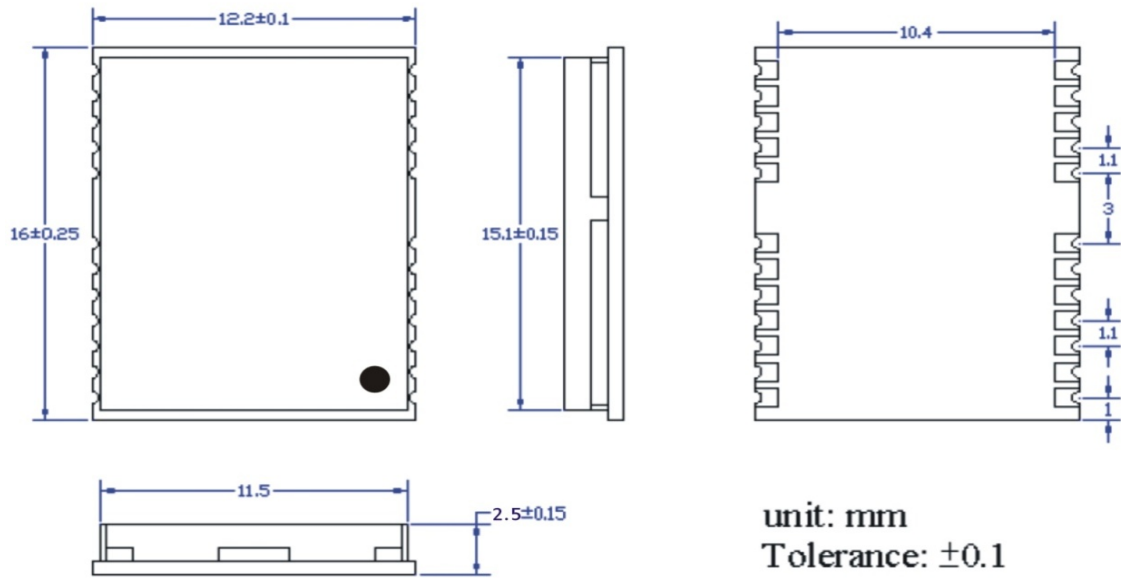

5. Recommended Footprint

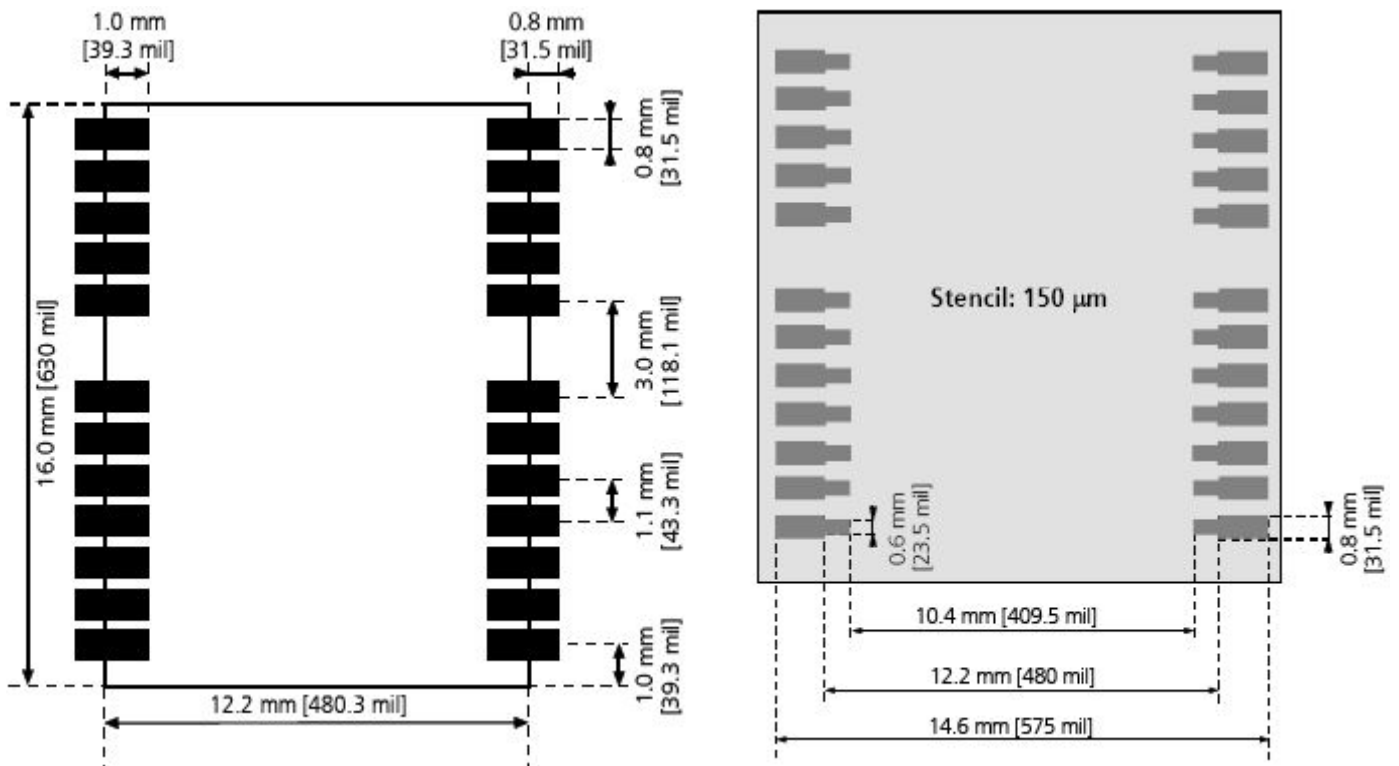

6. Application Circuit

6.1 With Active Antenna

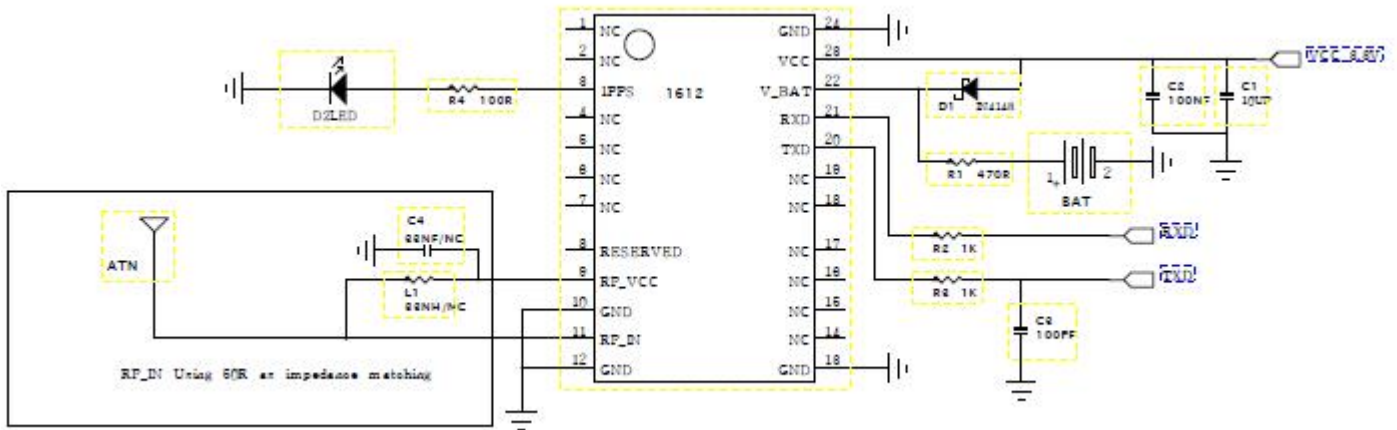

6.2 With Passive Antenna ,LNA & SAW Filter

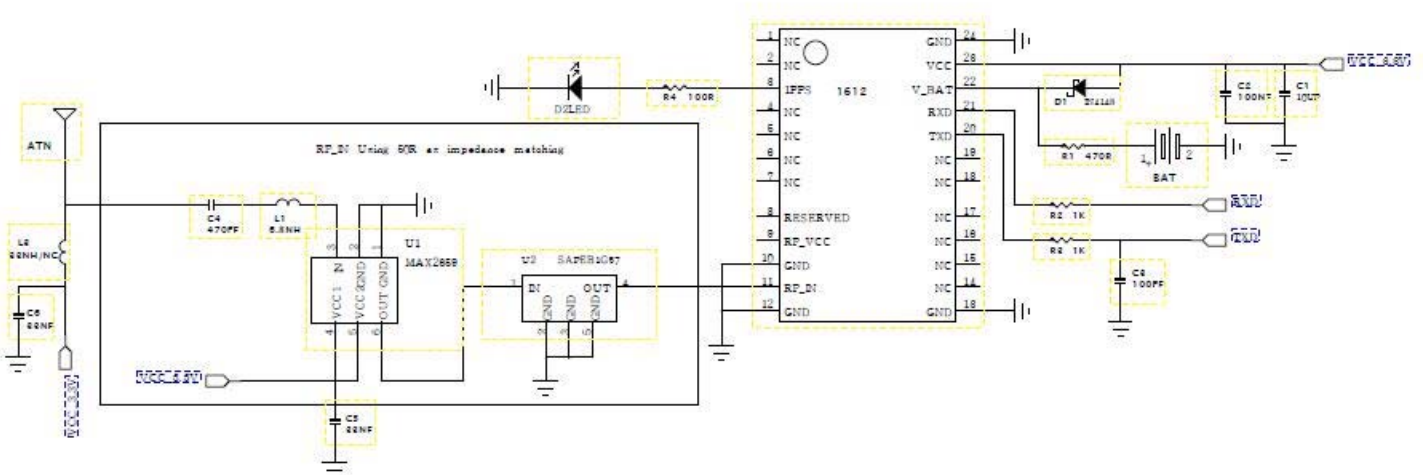

7. Reflow Profile

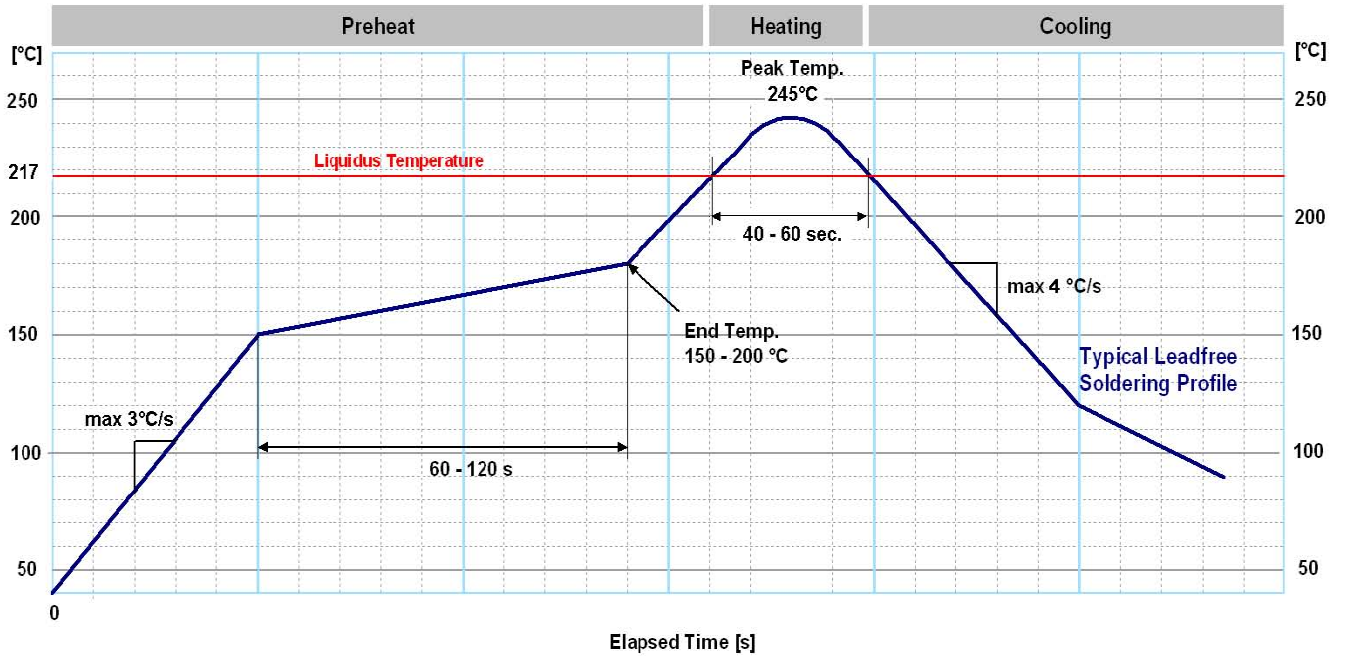

8. Tape & Reel (unit : mm)

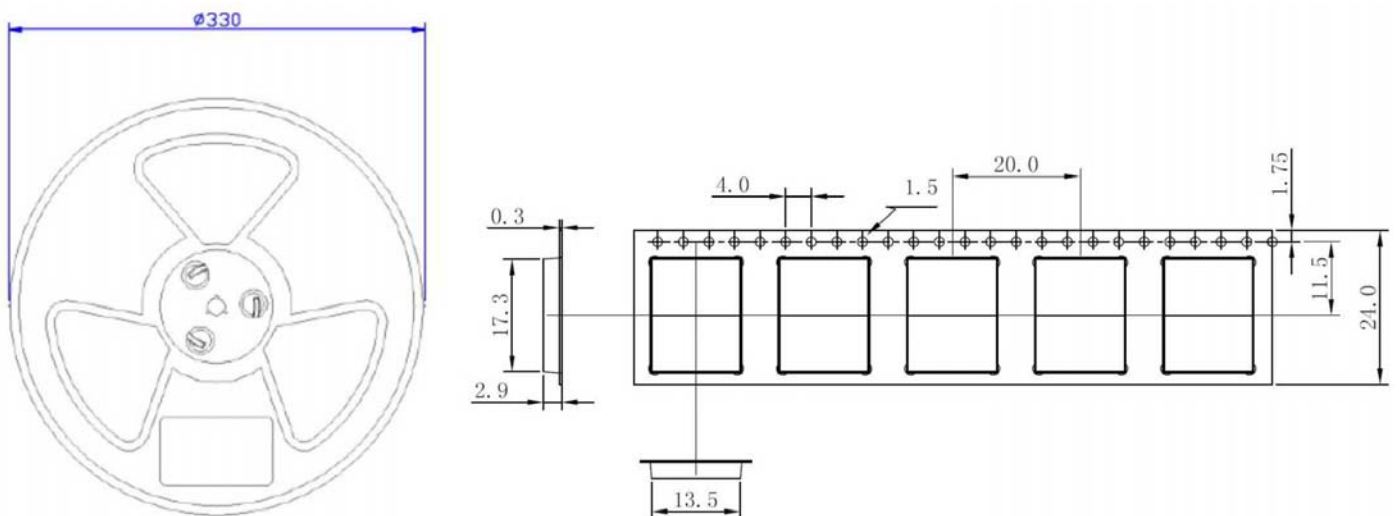

9. Software Interface

NMEA output message

Table 9.1 NMEA output message

NMEA	Description
GGA	Global positioning system fixed data
GLL	Geographic position - latitude/longitude
GSA	GNSS DOP and active satellites
GSV	GNSS satellites in view
RMC	Recommended minimum specific GNSS data
VTG	Course over ground and ground speed

GGA--- Global Positioning System Fixed Data

Table 9.2 contains the values for the following example:

\$GPGGA,060406.000,2503.7148,N,12138.7451,E,2,17,0.71,116.7,M,15.3,M,0000,0000*6D

Table 9.2 GGA Data Format

Name	Example	Units	Description
Message ID	\$GPGGA		GGA protocol header
UTC Time	060406.000		hhmmss.sss
Latitude	2503.7148		ddmm.mmmm
N/S indicator	N		N=north or S=south
Longitude	12138.7451		dddmm.mmmm
E/W Indicator	E		E=east or W=west
Position Fix Indicator	2		See Table 9.3
Satellites Used	17		Range 0 to 33
HDOP	0.71		Horizontal Dilution of Precision
MSL Altitude	116.7	mters	
Units	M	mters	
Geoid Separation	15.3	mters	
Units	M	mters	
Age of Diff. Corr.	0000	second	Null fields when DGPS is not used
Diff. Ref. Station ID	0000		
Checksum	*6D		
<CR> <LF>			End of message termination

Table 9.3 Position Fix Indicators

Value	Description
0	Fix not available or invalid
1	GPS SPS Mode, fix valid
2	Differential GPS, SPS Mode, fix valid
3-5	Not supported
6	Dead Reckoning Mode, fix valid

GLL--- Geographic Position – Latitude/Longitude

Table 9.4 contains the values for the following example:

\$GNGLL,2503.7148,N,12138.7451,E,060406.000,A,D*46

Table 9.4 GLL Data Format

Name	Example	Units	Description
Message ID	\$GNGLL		GLL protocol header (GPGLL or GNGLL; GP indicates the device receives GPS satellites signal only and GN indicates the position is calculated with BEIDOU satellite signal)
Latitude	2503.7148		ddmm.mmmm
N/S indicator	N		N=north or S=south
Longitude	12138.7451		dddmm.mmmm
E/W indicator	E		E=east or W=west
UTC Time	060406.000		hhmmss.sss
Status	A		A=data valid or V=data not valid
Mode	D		A=autonomous, D=DGPS, E=DR, N=Data not valid, R=Coarse Position, S=Simulator
Checksum	*46		
<CR> <LF>			End of message termination

GSA---GNSS DOP and Active Satellites

Table 9.5 contains the values for the following example:

\$GNGSA,A,3,22,21,18,12,24,25,14,15,193,,,,,1.18,0.71,0.95*2C

\$GNGSA,A,3,205,207,210,202,201,203,209,208,,,,,1.18,0.71,0.95*1C

Table 9.5 GSA Data Format

Name	Example	Units	Description
Message ID	\$GNGSA		GSA protocol header (GNGSA or GPGSA; GP indicates the device receives GPS satellites signal only and GN indicates the position is calculated with BEIDOU satellite signal).First row of GSA message contains GPS & QZSS satellites and second row of GSA message contains BEIDOU satellites.
Mode 1	A		See Table 9.6
Mode 2	3		See Table 9.7
ID of satellite used	22		Sv on Channel 1
ID of satellite used	21		Sv on Channel 2
....		
ID of satellite used			Sv on Channel 12
PDOP	1.18		Position Dilution of Precision
HDOP	0.71		Horizontal Dilution of Precision
VDOP	0.95		Vertical Dilution of Precision
Checksum	*2C		
<CR> <LF>			End of message termination

Table 9.6 Mode 1

Value	Description
M	Manual- forced to operate in 2D or 3D mode
A	Automatic-allowed to automatically switch 2D/3D

Table 9.7 Mode 2

Value	Description
1	Fix not available
2	2D
3	3D

GSV---GNSS Satellites in View

Table 9.8 contains the values for the following example:

\$GPGSV,6,1,21,18,78,169,36,209,72,273,36,22,63,309,38,207,63,328,38*7B

\$GPGSV,6,2,21,203,58,205,39,25,56,138,39,201,55,141,34,206,50,168,*45

\$GPGSV,6,3,21,210,49,282,34,12,48,076,39,204,39,118,,14,38,322,37*77

\$GPGSV,6,4,21,193,37,180,34,202,36,246,29,24,23,041,34,31,21,244,*71

\$GPGSV,6,5,21,21,17,198,33,205,16,258,28,15,12,092,33,208,09,169,30*7B

\$GPGSV,6,6,21,51,,,*7E

Table 9.8 GSV Data Format

Name	Example	Units	Description
Message ID	\$GPGSV		GSV protocol header
Total number of messages1	6		Range 1 to 6
Message number1	1		Range 1 to 6
Satellites in view	21		
Satellite ID	18		Channel 1 (Range 01 to 237), GPS Satellites ID : 01~32,SBAS Satellites ID : 33~64, QZSS Satellites ID:193~196, &BEIDOU Satellites ID : 201~214
Elevation	78	degrees	Channel 1 (Range 00 to 90)
Azimuth	169	degrees	Channel 1 (Range 000 to 359)
SNR (C/No)	36	dB-Hz	Channel 1 (Range 00 to 99, null when not tracking)
....
Satellite ID	207		Channel 4 (Range 01 to 237) , GPS Satellites ID : 01~32,SBAS Satellites ID : 33~64, QZSS Satellites ID:193~196, &BEIDOU Satellites ID : 201~214
Elevation	63	degrees	Channel 4 (Range 00 to 90)
Azimuth	328	degrees	Channel 4 (Range 000 to 359)
SNR (C/No)	38	dB-Hz	Channel 4 (Range 00 to 99, null when not tracking)
Checksum	*7B		
<CR> <LF>			End of message termination

Depending on the number of satellites tracked multiple messages of GSV data may be required.

RMC---Recommended Minimum Specific GNSS Data

Table 9.9 contains the values for the following example:

\$GNRMC,060406.000,A,2503.7148,N,12138.7451,E,0.01,0.00,180313,,D*78

Table 9.9 RMC Data Format

Name	Example	Units	Description
Message ID	\$GNRMC		RMC protocol header (GNRMC or GPRMC; GP indicates the device receives GPS satellites signal only and GN indicates the position is calculated with BEIDOU satellite signal)
UTC Time	060406.000		hhmmss.sss
Status	A		A=data valid or V=data not valid
Latitude	2503.7148		ddmm.mmmm
N/S Indicator	N		N=north or S=south
Longitude	12138.7451		dddmm.mmmm
E/W Indicator	E		E=east or W=west
Speed over ground	0.01	knots	True
Course over ground	0.00	degrees	
Date	180313		ddmmyy
Magnetic variation		degrees	
Variation sense			E=east or W=west (Not shown)
Mode	D		A=autonomous, D=DGPS, E=DR, N=Data not valid, R=Coarse Position, S=Simulator
Checksum	*78		
<CR> <LF>			End of message termination

VTG---Course Over Ground and Ground Speed

Table 9.10 contains the values for the following example:

\$GPVTG,0.00,T,,M,0.01,N,0.02,K,D*3B

Table 9.10 VTG Data Format

Name	Example	Units	Description
Message ID	\$GPVTG		VTG protocol header
Course over ground	0.00	degrees	Measured heading
Reference	T		True
Course over ground		degrees	Measured heading
Reference	M		Magnetic
Speed over ground	0.01	knots	Measured speed
Units	N		Knots
Speed over ground	0.02	km/hr	Measured speed
Units	K		Kilometer per hour
Mode	D		A=autonomous, D=DGPS, E=DR, N=Data not valid, R=Coarse Position, S=Simulator
Checksum	*3B		
<CR> <LF>			End of message termination